

Distribution Box

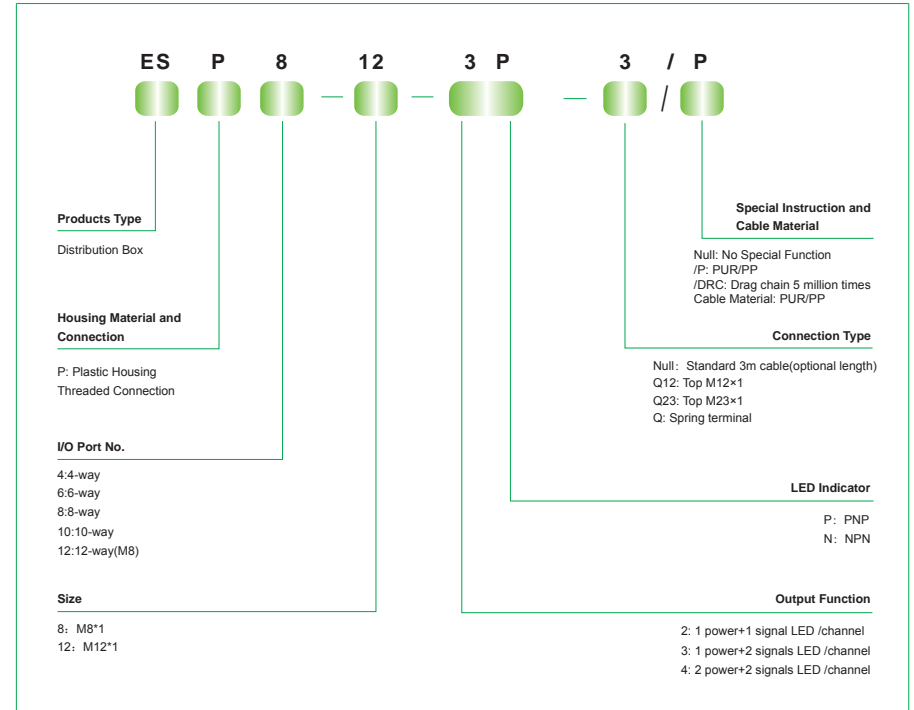


Distribution Box

Elco supplies metal and plastic housing junction box. Metal junction box is circular connector wiring, while plastic junction box is divided into straight wiring and terminal wiring products. All junction box products up to IP67 provide economical and practical wiring system in the sensors and actuators working area. Sensing and executive signal need transferring and extending, and the junction box is imperative, because it can connect with large criss-cross controlling system easily and quickly. Meanwhile, Elco has multi-branch box for DeviceNet, including 4, 6, 8 terminal inlet and 2, 4, 6 terminal inlet/outlet products.

- LED indicator for diagnosing input signal and power error of all products.
- Junction box interface for selection: M8 M12
- Supplying 4 and 8 channel products for selection.
- Wiring type: pre-wired, M23 interface wiring and terminal wiring
- Metal and plastic housing for selection
- One I/O interface importing 2 signals
- Field wiring products with plastic terminal choosing 2-zone power mode
- Indication function: PNP NPN

Distribution Box Type Code



Plastic distribution box ESP4 series (M8 socket, with M12 plug connector)

Description:				
Plastic housing, distributed design, 4-way, single/double signal.				
Features:				
<ul style="list-style-type: none"> Optional output (PNP/NPN) LED indicator and high protection class IP67 Compact size - 93mm, especially suitable for small space installation Standard 3m PUR cable for M12 connector, optional cable material and length 				
Type List				
	ESP4-8-2P-Q12	ESP4-8-2N-Q12	ESP4-8-3P-Q12	ESP4-8-3N-Q12
Technical Data				
Output Function	1 signal		2 signals	
Output Type	PNP	NPN	PNP	NPN
Connection for Sensors/Actuators	3-pin M8 female		4-pin M8 female	
Locking Sockets	Threaded M8x1			
Dimensions	Fig.1,3		Fig.2,3	
Pin Assignment	Fig.4		Fig.5	
Wiring Diagram	Fig.9	Fig.10	Fig.11	Fig.12
Supply Voltage	10...30VDC (24VDC)			
Supply Voltage Indicator	LED green			
I/O Channels	4		1	
Signals per Port	1		2	
Status Indicators	LED yellow		LED yellow / red	
Operating Current	Max. 1.5A			
Current Parameter	Max. 1.5A			
	Please do not operate cables above max. load capacity.			
Housing Material	Plastic			
	PC + ABS			
Protection Class	IP67			
Temperature Range	-40...+80°C			
Resistance	Good resistance against chemicals and oils. The resistance to aggressive media should be individually verified for your application.			
Connector	M12(12pins)			
Dimensions				

Accessories of Distribution Box -Connector																												
Type List																												
Type	CO12.12-3 / P	CBO12.12-3 / P																										
Description	Straight pre-wired connector	Angled pre-wired connector																										
Cable Material	Standard PUR / PP Bendingø5 million																											
Cable Length	3m																											
Dimensions	Fig. 6	Fig. 7																										
Pin Assignment	Fig. 8	Fig. 8																										
Dimensions																												
Fig. 6		Fig. 7																										
Pin Assignment																												
Fig. 8		<table border="1"> <thead> <tr> <th>12-pin M12 Male</th> <th>Suggested Cable Color</th> </tr> </thead> <tbody> <tr><td>1</td><td>BN</td></tr> <tr><td>2</td><td>BU</td></tr> <tr><td>3</td><td>WH</td></tr> <tr><td>4</td><td>GN</td></tr> <tr><td>5</td><td>PK</td></tr> <tr><td>6</td><td>YE</td></tr> <tr><td>7</td><td>BK</td></tr> <tr><td>8</td><td>GY</td></tr> <tr><td>9</td><td>RD</td></tr> <tr><td>10</td><td>VT</td></tr> <tr><td>11</td><td>GY/PK</td></tr> <tr><td>12</td><td>RD/BU</td></tr> </tbody> </table>	12-pin M12 Male	Suggested Cable Color	1	BN	2	BU	3	WH	4	GN	5	PK	6	YE	7	BK	8	GY	9	RD	10	VT	11	GY/PK	12	RD/BU
12-pin M12 Male	Suggested Cable Color																											
1	BN																											
2	BU																											
3	WH																											
4	GN																											
5	PK																											
6	YE																											
7	BK																											
8	GY																											
9	RD																											
10	VT																											
11	GY/PK																											
12	RD/BU																											
Wiring Diagram																												
Fig. 9 Connector		Fig. 10 Connector																										
	LED indicator PNP	LED indicator NPN																										
Fig. 11 Connector		Fig. 12 Connector																										
	LED indicator PNP	LED indicator NPN																										

Plastic distribution box ESP4 series (M8 socket, with pre-wired cable)

Description:				
Plastic housing, 4-way, pre-wired cable, single/double signal.				
Features:				
<ul style="list-style-type: none"> Optional output (PNP/NPN) LED indicator and high protection class IP67 Compact size - 93mm, especially suitable for small space installation Standard 3m PUR cable, optional cable length 				
Type List				
	ESP4-8-2P-3 / P	ESP4-8-2N-3 / P	ESP4-8-3P-3 / P	ESP4-8-3N-3 / P
Technical Data				
Output Function	1 signal		2 signals	
Output Type	PNP	NPN	PNP	NPN
Connection for Sensors/Actuators	3-pin M8 female		4-pin M8 female	
Locking Sockets	Threaded M8x1			
Dimensions	Fig.1,3		Fig.2,3	
Pin Assignment	Fig.4		Fig.5	
Wiring Diagram	Fig. 6	Fig. 7	Fig. 8	Fig. 9
Supply Voltage	10...30VDC (24VDC)			
Supply Voltage Indicator	LED green			
I/O Channels	4		4	
Signals per Port	1		2	
Status Indicators	LED yellow		LED yellow / red	
Operating Current	Max. 2A			
Current Parameter	Max. 8A			
	Please do not operate cables above max. load capacity.			
Housing Material	Plastic			
	PC + ABS			
Protection Class	IP67			
Temperature Range	-40...+80°C			
Resistance	Good resistance against chemicals and oils. The resistance to aggressive media should be individually verified for your application.			
Cable Material	Standard PUR / PP Bending≥5 million			
Length	3m			
Dimensions			Pin Assignment	
			Fig. 4 3-pin PNP/NPN 1 signal	
			Fig. 5 4-pin PNP/NPN 2 signals	

Wiring Diagram	
Fig. 6 Cable LED indicator PNP	Fig. 7 Cable LED indicator NPN
Fig. 8 Cable LED indicator PNP	Fig. 9 Cable LED indicator NPN

Plastic distribution box ESP6 series (M8 socket, with M12 plug connector)

Description:		
Plastic housing, distributed design, 6-way, single signal.		
Features:		
<ul style="list-style-type: none"> Optional output (PNP/NPN) LED indicator and high protection class IP67 Compact size - 110mm, especially suitable for small space installation Standard 3m PUR cable for M12 connector, optional cable material and length 		
Type List		
	ESP6-8-2P-Q12	ESP6-8-2N-Q12
Technical Data		
Output Function	1 signal	
Output Type	PNP	NPN
Connection for Sensors/Actuators	3-pin M8 female	
Locking Sockets	Threaded M8x1	
Dimensions	Fig. 1	
Pin Assignment	Fig. 2	
Wiring Diagram	Fig. 6	Fig. 7
Supply Voltage	10...30VDC (24VDC)	
Supply Voltage Indicator	LED green	
I/O Channels	6	
Signals per Port	1	
Status Indicators	LED yellow	
Operating Current	Max. 1.5A	
Current Parameter	Max. 1.5A	
	Please do not operate cables above max. load capacity.	
Housing Material	Plastic	
	PC + ABS	
Protection Class	IP67	
Temperature Range	-40...+80°C	
Resistance	Good resistance against chemicals and oils. The resistance to aggressive media should be individually verified for your application.	
Connector	M12(12pins)	
Dimensions		
Fig. 1		
Pin Assignment		
Fig. 2	<p>3-pin PNP/NPN 1 signal</p>	

Accessories of Distribution Box -Connector																												
Type List																												
Type	CO12.12-3 / P	CBO12.12-3 / P																										
Description	Straight pre-wired connector	Angled pre-wired connector																										
Cable Material	Standard PUR / PP Bending \geq 5 million																											
Cable Length	3m																											
Dimensions	Fig. 3	Fig. 4																										
Pin Assignment	Fig. 5																											
Dimensions																												
Fig. 3																												
Fig. 4																												
Pin Assignment																												
Fig. 5	<table border="1"> <thead> <tr> <th>12-pin M12 Male</th> <th>Suggested Cable Color</th> </tr> </thead> <tbody> <tr><td>1</td><td>BN</td></tr> <tr><td>2</td><td>BU</td></tr> <tr><td>3</td><td>WH</td></tr> <tr><td>4</td><td>GN</td></tr> <tr><td>5</td><td>PK</td></tr> <tr><td>6</td><td>YE</td></tr> <tr><td>7</td><td>BK</td></tr> <tr><td>8</td><td>GY</td></tr> <tr><td>9</td><td>RD</td></tr> <tr><td>10</td><td>VT</td></tr> <tr><td>11</td><td>GY/PK</td></tr> <tr><td>12</td><td>RD/BU</td></tr> </tbody> </table>		12-pin M12 Male	Suggested Cable Color	1	BN	2	BU	3	WH	4	GN	5	PK	6	YE	7	BK	8	GY	9	RD	10	VT	11	GY/PK	12	RD/BU
12-pin M12 Male	Suggested Cable Color																											
1	BN																											
2	BU																											
3	WH																											
4	GN																											
5	PK																											
6	YE																											
7	BK																											
8	GY																											
9	RD																											
10	VT																											
11	GY/PK																											
12	RD/BU																											
Wiring Diagram																												
Fig. 6	<p>LED indicator PNP</p>																											
Fig. 7	<p>LED indicator NPN</p>																											

Plastic distribution box ESP6 series (M8 socket, with pre-wired cable)

Description:				
Plastic housing, 6-way, pre-wired cable, single/double signal.				
Features:				
<ul style="list-style-type: none"> Optional output (PNP/NPN) LED indicator and high protection class IP67 Compact size - 110mm, especially suitable for small space installation Standard 3m PUR cable, optional cable length 				
Type List	ESP6-8-2P-3 / P	ESP6-8-2N-3 / P	ESP6-8-3P-3 / P	ESP6-8-3N-3 / P
Technical Data				
Output Function	1 signal		2 signals	
Output Type	PNP	NPN	PNP	NPN
Connection for Sensors/Actuators	3-pin M8 female		4-pin M8 female	
Locking Sockets	Threaded M8x1			
Dimensions	Fig.1,3		Fig.2,3	
Pin Assignment	Fig.4		Fig.5	
Wiring Diagram	Fig.6	Fig.7	Fig.8	Fig.9
Supply Voltage	10...30VDC (24VDC)			
Supply Voltage Indicator	LED green			
I/O Channels	6		6	
Signals per Port	1		2	
Status Indicators	LED yellow		LED yellow / red	
Operating Current	Max. 2A			
Current Parameter	Max. 8A			
	Please do not operate cables above max. load capacity.			
Housing Material	Plastic			
	PC + ABS			
Protection Class	IP67			
Temperature Range	-40...+80°C			
Resistance	Good resistance against chemicals and oils. The resistance to aggressive media should be individually verified for your application.			
Cable Material	Standard PUR / PP Bending≥5 million			
Length	3m			
Dimensions			Pin Assignment	
			Fig. 4 3-pin PNP/NPN 1 signal	
			Fig. 5 4-pin PNP/NPN 2 signals	


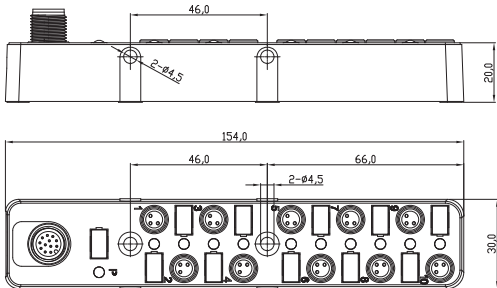
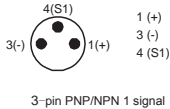
Wiring Diagram	
Fig. 6 Cable	
	LED indicator PNP
Fig. 7 Cable	
	LED indicator NPN
Fig. 8 Cable	
	LED indicator PNP
Fig. 9 Cable	
	LED indicator NPN


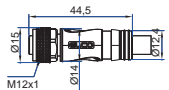
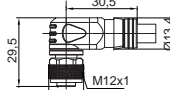
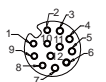
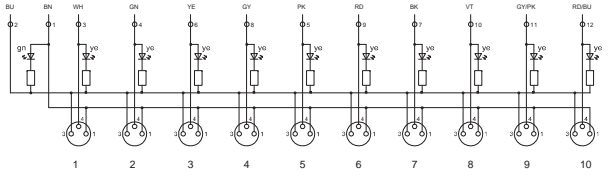
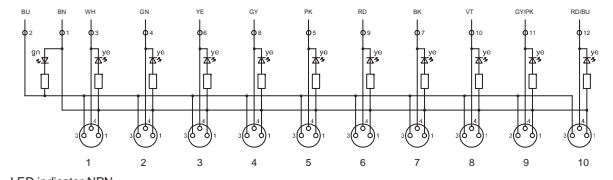
Plastic distribution box ESP8 series (M8 socket, with M12 plug connector)

Description:		
Plastic housing, distributed design, 8-way, single signal.		
Features:		
<ul style="list-style-type: none"> Optional output (PNP/NPN) LED indicator and high protection class IP67 Compact size - 130mm, especially suitable for small space installation Standard 3m PUR cable for M12 connector, optional cable material and length 		
Type List		
	ESP8-8-2P-Q12	ESP8-8-2N-Q12
Technical Data		
Output Function	1 signal	
Output Type	PNP	NPN
Connection for Sensors/Actuators	3-pin M8 female	
Locking Sockets	Threaded M8x1	
Dimensions	Fig.1	
Pin Assignment	Fig.2	
Wiring Diagram	Fig.6	Fig.7
Supply Voltage	10...30VDC (24VDC)	
Supply Voltage Indicator	LED green	
I/O Channels	8	
Signals per Port	1	
Status Indicators	LED yellow	
Operating Current	Max. 1.5A	
Current Parameter	Max. 1.5A	
	Please do not operate cables above max. load capacity.	
Housing Material	Plastic	
	PC + ABS	
Protection Class	IP67	
Temperature Range	-40...+80°C	
Resistance	Good resistance against chemicals and oils. The resistance to aggressive media should be individually verified for your application.	
Connector	M12(12pins)	
Dimensions		Pin Assignment
Fig. 1		Fig. 2

Accessories of Distribution Box -Connector																												
Type List																												
Type	CO12.12-3 / P	CBO12.12-3 / P																										
Description	Straight pre-wired connector	Angled pre-wired connector																										
Cable Material	Standard PUR / PP Bending \geq 5 million	Standard PUR / PP Bending \geq 5 million																										
Cable Length	3m	3m																										
Dimensions	Fig. 3	Fig. 4																										
Pin Assignment	Fig. 5	Fig. 5																										
Dimensions	Fig. 3	Fig. 4																										
Pin Assignment	Fig. 5																											
		<table border="1"> <thead> <tr> <th>12-pin M12 Male</th> <th>Suggested Cable Color</th> </tr> </thead> <tbody> <tr><td>1</td><td>BN</td></tr> <tr><td>2</td><td>BU</td></tr> <tr><td>3</td><td>WH</td></tr> <tr><td>4</td><td>GN</td></tr> <tr><td>5</td><td>PK</td></tr> <tr><td>6</td><td>YE</td></tr> <tr><td>7</td><td>BK</td></tr> <tr><td>8</td><td>GY</td></tr> <tr><td>9</td><td>RD</td></tr> <tr><td>10</td><td>VT</td></tr> <tr><td>11</td><td>GY/PK</td></tr> <tr><td>12</td><td>RD/BU</td></tr> </tbody> </table>	12-pin M12 Male	Suggested Cable Color	1	BN	2	BU	3	WH	4	GN	5	PK	6	YE	7	BK	8	GY	9	RD	10	VT	11	GY/PK	12	RD/BU
12-pin M12 Male	Suggested Cable Color																											
1	BN																											
2	BU																											
3	WH																											
4	GN																											
5	PK																											
6	YE																											
7	BK																											
8	GY																											
9	RD																											
10	VT																											
11	GY/PK																											
12	RD/BU																											
Wiring Diagram																												
Fig. 6																												
Connector	LED indicator PNP																											
Fig. 7																												
Connector	LED indicator NPN																											

Plastic distribution box ESP10 series (M8 socket, with M12 plug connector)

Description:		
Plastic housing, distributed design, 10-way, single signal.		
Features:		
<ul style="list-style-type: none"> ■ Optional output (PNP/NPN) ■ LED indicator and high protection class IP67 ■ Compact size - 154mm, especially suitable for small space installation ■ Standard 3m PUR cable for M12 connector, optional cable material and length 		
		
Type List	ESP10-8-2P-Q12	ESP10-8-2N-Q12
Technical Data		
Output Function	1 signal	
Output Type	PNP	NPN
Connection for Sensors/Actuators	3-pin M8 female	
Locking Sockets	Threaded M8x1	
Dimensions	Fig.1	
Pin Assignment	Fig.2	
Wiring Diagram	Fig.6	Fig.7
Supply Voltage	10...30VDC (24VDC)	
Supply Voltage Indicator	LED green	
I/O Channels	10	
Signals per Port	1	
Status Indicators	LED yellow	
Operating Current	Max. 1.5A	
Current Parameter	Max. 1.5A	
	Please do not operate cables above max. load capacity.	
Housing Material	Plastic	
	PC + ABS	
Protection Class	IP67	
Temperature Range	-40...+80°C	
Resistance	Good resistance against chemicals and oils. The resistance to aggressive media should be individually verified for your application.	
Connector	M12(12pins)	
Dimensions		Pin Assignment
Fig. 1		Fig. 2
		

Accessories of Distribution Box -Connector																												
																												
Type List																												
Type	CO12.12-3 / P	CBO12.12-3 / P																										
Description	Straight pre-wired connector	Angled pre-wired connector																										
Cable Material	Standard PUR / PP Bendingø5 million	Standard PUR / PP Bendingø5 million																										
Cable Length	3m	3m																										
Dimensions	Fig. 3	Fig. 4																										
Pin Assignment	Fig. 5	Fig. 5																										
Dimensions		Pin Assignment																										
Fig. 3		Fig. 4																										
																												
Fig. 5		<table border="1"> <thead> <tr> <th>12-pin M12 Male</th> <th>Suggested Cable Color</th> </tr> </thead> <tbody> <tr><td>1</td><td>BN</td></tr> <tr><td>2</td><td>BU</td></tr> <tr><td>3</td><td>WH</td></tr> <tr><td>4</td><td>GN</td></tr> <tr><td>5</td><td>PK</td></tr> <tr><td>6</td><td>YE</td></tr> <tr><td>7</td><td>BK</td></tr> <tr><td>8</td><td>GY</td></tr> <tr><td>9</td><td>RD</td></tr> <tr><td>10</td><td>VT</td></tr> <tr><td>11</td><td>GY/PK</td></tr> <tr><td>12</td><td>RD/BU</td></tr> </tbody> </table>	12-pin M12 Male	Suggested Cable Color	1	BN	2	BU	3	WH	4	GN	5	PK	6	YE	7	BK	8	GY	9	RD	10	VT	11	GY/PK	12	RD/BU
12-pin M12 Male	Suggested Cable Color																											
1	BN																											
2	BU																											
3	WH																											
4	GN																											
5	PK																											
6	YE																											
7	BK																											
8	GY																											
9	RD																											
10	VT																											
11	GY/PK																											
12	RD/BU																											
																												
Wiring Diagram																												
Fig. 6																												
Connector																												
																												
LED indicator PNP																												
Fig. 7																												
Connector																												
																												
LED indicator NPN																												

Plastic distribution box ESP10 series (M8 socket, with pre-wired cable)

Description:				
Plastic housing, 10-way, pre-wired cable, single/double signal.				
Features:				
<ul style="list-style-type: none"> ■ Optional output (PNP/NPN) ■ LED indicator and high protection class IP67 ■ Compact size - 154mm, especially suitable for small space installation ■ Standard 3m PUR cable, optional cable length 				
Type List				
	ESP10-8-2P-3 / P	ESP10-8-2N-3 / P	ESP10-8-3P-3 / P	ESP10-8-3N-3 / P
Technical Data				
Output Function	1 signal		2 signals	
Output Type	PNP	NPN	PNP	NPN
Connection for Sensors/Actuators	3-pin M8 female		4-pin M8 female	
Locking Sockets	Threaded M8x1			
Dimensions	Fig.1,3		Fig.2,3	
Pin Assignment	Fig.4		Fig.5	
Wiring Diagram	Fig.6	Fig.7	Fig.8	Fig.9
Supply Voltage	10...30VDC (24VDC)			
Supply Voltage Indicator	LED green			
I/O Channels	10			
Signals per Port	1		2	
Status Indicators	LED yellow		LED yellow / red	
Operating Current	Max. 2A			
Current Parameter	Max. 8A			
	Please do not operate cables above max. load capacity.			
Housing Material	Plastic			
	ABS			
Protection Class	IP67			
Temperature Range	-40...+80 °C			
Resistance	Good resistance against chemicals and oils. The resistance to aggressive media should be individually verified for your application.			
Cable Material	Standard PUR / PP Bendings=5 million			
Length	3m			
Dimensions			Pin Assignment	
Fig. 1	Fig. 2	Fig. 3	Fig. 4	
			<p>3(-) 1(+)</p> <p>3-pin PNP/NPN 1 signal</p>	
			Fig. 5	
			<p>4 (S1) 2 (S2)</p> <p>3 (-) 1 (+)</p> <p>4-pin PNP/NPN 2 signals</p>	

Wiring Diagram

Fig. 6
Cable

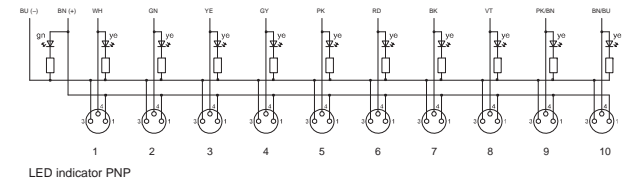


Fig. 7
Cable

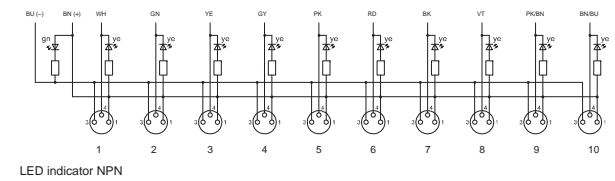


Fig. 8
Cable

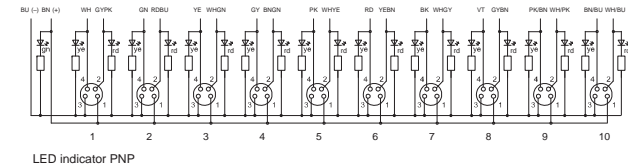
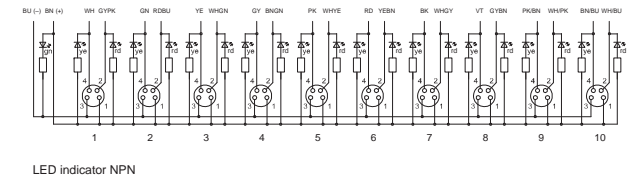

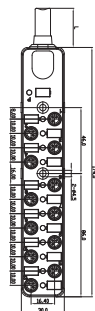
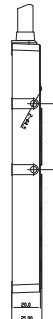
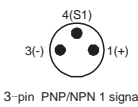
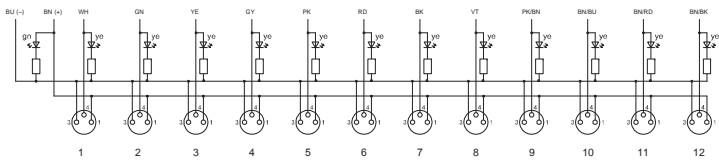
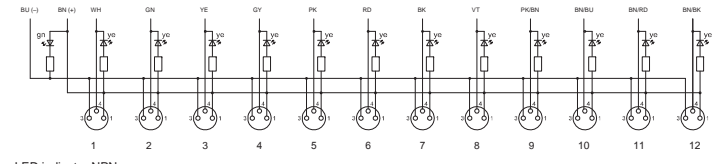


Fig. 9
Cable



Plastic distribution box ESP12 series (M8 socket, with pre-wired cable)

Description:		
Plastic housing, 12-way, pre-wired cable, single signal.		
Features:		
<ul style="list-style-type: none"> ■ Optional output (PNP/NPN) ■ LED indicator and high protection class IP67 ■ Standard 3m PUR cable, optional cable length 		
Type List	ESP12-8-2P-3 / P	ESP12-8-2N-3 / P
Technical Data		
Output Function	1 signal	
Output Type	PNP	NPN
Connection for Sensors/Actuators	3-pin M8 female	
Locking Sockets	Threaded M8x1	
Dimensions	Fig.1,2	
Pin Assignment	Fig.3	
Wiring Diagram	Fig.4	Fig.5
Supply Voltage	10...30VDC (24VDC)	
Supply Voltage Indicator	LED green	
I/O Channels	12	
Signals per Port	1	
Status Indicators	LED yellow	
Operating Current	Max. 2A	
Current Parameter	Max. 8A	
	Please do not operate cables above max. load capacity.	
Housing Material	Plastic	
	ABS	
Protection Class	IP67	
Temperature Range	-40...+80°C	
Resistance	Good resistance against chemicals and oils. The resistance to aggressive media should be individually verified for your application.	
Cable Material	Standard PUR / PP Bending≥5 million	
Length	3m	
Dimensions		Pin Assignment
Fig. 1	Fig. 2	Fig. 3
		

Wiring Diagram	
Fig. 4 Cable	
	
LED indicator PNP	
Fig. 5 Cable	
	
LED indicator NPN	

Plastic distribution box ESP4 series (M12 socket, with M12 plug connector)

Description:				
Plastic housing, distributed design, 4-way, single/double signal.				
Features:				
<ul style="list-style-type: none"> ■ Optional output (PNP/NPN) ■ LED indicator and high protection class IP67 ■ Standard 3m PUR cable for M12 connector, optional cable material and length 				
Type List				
	ESP4-12-2P-Q12	ESP4-12-2N-Q12	ESP4-12-3P-Q12	ESP4-12-3N-Q12
Technical Data				
Output Function	1 signal		2 signals	
Output Type	PNP	NPN	PNP	NPN
Connection for Sensors/Actuators	4-pin M12 female		5-pin M12 female	
Locking Sockets	Threaded M12x1			
Dimensions	Fig. 1			
Pin Assignment	Fig. 2		Fig. 3	
Wiring Diagram	Fig. 7	Fig. 8	Fig. 9	Fig.10
Supply Voltage	10...30VDC (24VDC)			
Supply Voltage Indicator	LED green			
I/O Channels	4			
Signals per Port	1		2	
Status Indicators	LED yellow			
Operating Current	Max. 1.5A / per contact			
Current Parameter	Max. 1.5A			
	Please do not operate cables above max. load capacity.			
Housing Material	Plastic			
	PC + ABS			
Protection Class	IP67			
Temperature Range	-40...+80°C			
Resistance	Good resistance against chemicals and oils. The resistance to aggressive media should be individually verified for your application.			
Connector	M12(12pins)			
Dimensions				
Fig. 1				
Pin Assignment		Fig. 2		
		Fig. 3		

Accessories of Distribution Box -Connector																												
Type List																												
Type	CO12.12-3 / P	CBO12.12-3 / P																										
Description	Straight pre-wired connector	Angled pre-wired connector																										
Cable Material	Standard PUR / PP Bending≥5 million	Standard PUR / PP Bending≥5 million																										
Cable Length	3m	3m																										
Dimensions	Fig. 4	Fig. 5																										
Pin Assignment	Fig. 6	Fig. 6																										
Dimensions																												
Fig. 4																												
Fig. 5																												
Pin Assignment																												
Fig. 6																												
	<table border="1"> <thead> <tr> <th>12-pin M12 Male</th> <th>Suggested Cable Color</th> </tr> </thead> <tbody> <tr><td>1</td><td>BN</td></tr> <tr><td>2</td><td>BU</td></tr> <tr><td>3</td><td>WH</td></tr> <tr><td>4</td><td>GN</td></tr> <tr><td>5</td><td>PK</td></tr> <tr><td>6</td><td>YE</td></tr> <tr><td>7</td><td>BK</td></tr> <tr><td>8</td><td>GY</td></tr> <tr><td>9</td><td>RD</td></tr> <tr><td>10</td><td>VT</td></tr> <tr><td>11</td><td>GY/PK</td></tr> <tr><td>12</td><td>RD/BU</td></tr> </tbody> </table>		12-pin M12 Male	Suggested Cable Color	1	BN	2	BU	3	WH	4	GN	5	PK	6	YE	7	BK	8	GY	9	RD	10	VT	11	GY/PK	12	RD/BU
12-pin M12 Male	Suggested Cable Color																											
1	BN																											
2	BU																											
3	WH																											
4	GN																											
5	PK																											
6	YE																											
7	BK																											
8	GY																											
9	RD																											
10	VT																											
11	GY/PK																											
12	RD/BU																											
Wiring Diagram																												
Fig. 7 Connector	Fig. 8 Connector																											
Fig. 9 Connector	Fig. 10 Connector																											

Plastic distribution box ESP4 series (M12 socket, with M23 plug connector)

Description:				
Plastic housing, distributed design, 4-way, single/double signal.				
Features:				
<ul style="list-style-type: none"> Optional output (PNP/NPN) LED indicator and high protection class IP67 Standard 3m PUR cable for M23 connector, optional cable material and length 				
Type List	ESP4-12-2P-Q23	ESP4-12-2N-Q23	ESP4-12-3P-Q23	ESP4-12-3N-Q23
Technical Data				
Output Function	1 signal		2 signals	
Output Type	PNP	NPN	PNP	NPN
Connection for Sensors/Actuators	4-pin M12 female		5-pin M12 female	
Locking Sockets	Threaded M12x1			
Dimensions	Fig. 1		Fig. 3	
Pin Assignment	Fig. 2		Fig. 3	
Wiring Diagram	Fig. 8	Fig. 9	Fig. 10	Fig. 11
Supply Voltage	10...30VDC (24VDC)			
Supply Voltage Indicator	LED green			
I/O Channels	4			
Signals per Port	1		2	
Status Indicators	LED yellow			
Operating Current	Max. 2A / per contact			
Current Parameter	Max. 8A			
	Please do not operate cables above max. load capacity.			
Housing Material	Plastic			
	PC + ABS			
Protection Class	IP67			
Temperature Range	-40...+80°C			
Resistance	Good resistance against chemicals and oils. The resistance to aggressive media should be individually verified for your application.			
Connector	M23(19pins)			
Dimensions				
Fig. 1			Pin Assignment	
			Fig. 2	
			<p>4-pin</p>	
			Fig. 3	
			<p>5-pin</p>	

Accessories of Distribution Box -Connector																																																							
Type List	LSO23.19-0	LSBO23.19-0	CO23.19-3/P																																																				
Type	Straight field-attachment connector	Angled field-attachment connector	Straight pre-wired connector																																																				
Description	--	--	Standard PUR/ PP Bendige=5 million																																																				
Cable Material	--	--	3m																																																				
Cable Length	Fig. 4	Fig. 5	Fig. 6																																																				
Dimensions	Fig. 7	Fig. 7	Fig. 7																																																				
Dimensions																																																							
Fig. 4																																																							
Pin Assignment																																																							
Fig. 7		<table border="1"> <thead> <tr> <th>19-pin M19 Male</th> <th>Suggested Cable Color</th> <th>19-pin M19 Male</th> <th>Suggested Cable Color</th> </tr> </thead> <tbody> <tr><td>1</td><td>VT</td><td>13</td><td>YE/BN</td></tr> <tr><td>2</td><td>RD</td><td>14</td><td>BN/GRN</td></tr> <tr><td>3</td><td>GY</td><td>15</td><td>WH</td></tr> <tr><td>4</td><td>RD/BU</td><td>16</td><td>YE</td></tr> <tr><td>5</td><td>GN</td><td>17</td><td>PK</td></tr> <tr><td>6</td><td>BU</td><td>18</td><td>GY/BN</td></tr> <tr><td>7</td><td>GY/PK</td><td>19</td><td>BN</td></tr> <tr><td>8</td><td>WH/GRN</td><td></td><td></td></tr> <tr><td>9</td><td>WH/YE</td><td></td><td></td></tr> <tr><td>10</td><td>WH/GY</td><td></td><td></td></tr> <tr><td>11</td><td>BK</td><td></td><td></td></tr> <tr><td>12</td><td>GN/YE</td><td></td><td></td></tr> </tbody> </table>	19-pin M19 Male	Suggested Cable Color	19-pin M19 Male	Suggested Cable Color	1	VT	13	YE/BN	2	RD	14	BN/GRN	3	GY	15	WH	4	RD/BU	16	YE	5	GN	17	PK	6	BU	18	GY/BN	7	GY/PK	19	BN	8	WH/GRN			9	WH/YE			10	WH/GY			11	BK			12	GN/YE			
19-pin M19 Male	Suggested Cable Color	19-pin M19 Male	Suggested Cable Color																																																				
1	VT	13	YE/BN																																																				
2	RD	14	BN/GRN																																																				
3	GY	15	WH																																																				
4	RD/BU	16	YE																																																				
5	GN	17	PK																																																				
6	BU	18	GY/BN																																																				
7	GY/PK	19	BN																																																				
8	WH/GRN																																																						
9	WH/YE																																																						
10	WH/GY																																																						
11	BK																																																						
12	GN/YE																																																						
Wiring Diagram																																																							
Fig. 8	<p>LED indicator PNP</p>		Fig. 9	<p>LED indicator NPN</p>																																																			
Fig. 10	<p>LED indicator PNP</p>		Fig. 11	<p>LED indicator NPN</p>																																																			

Plastic distribution box ESP4 series (M12 socket, with pre-wired cable)

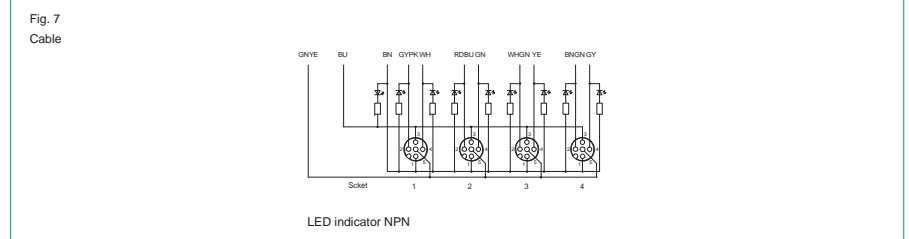
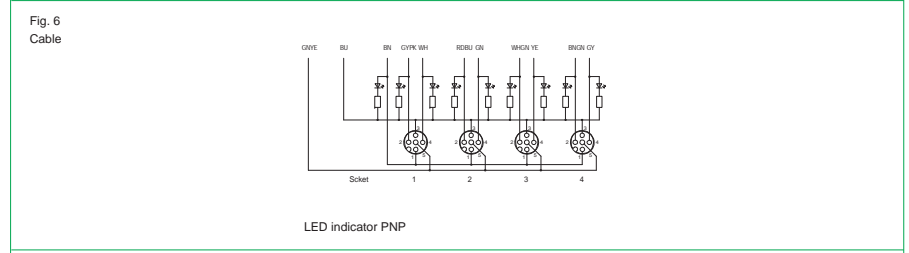
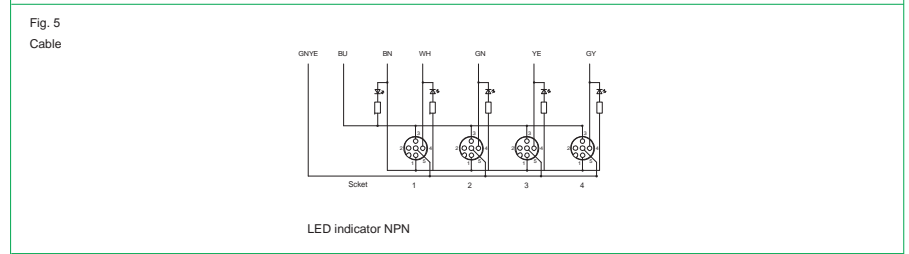
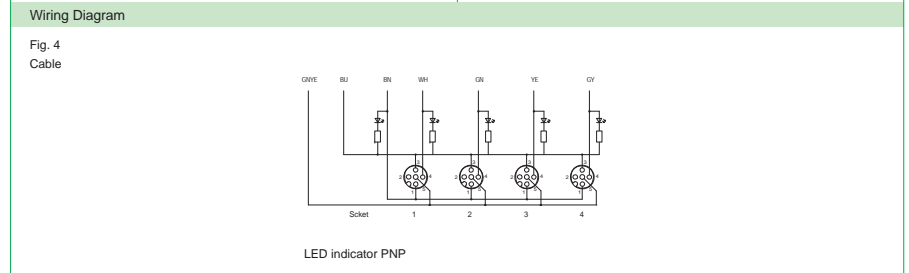
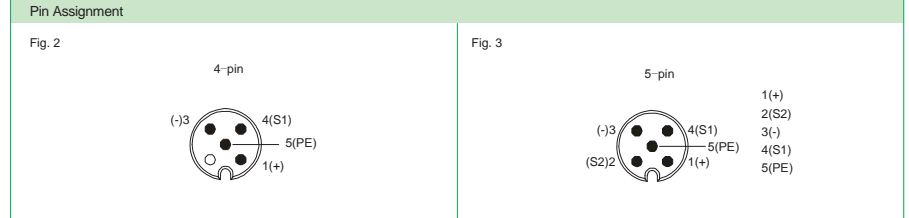
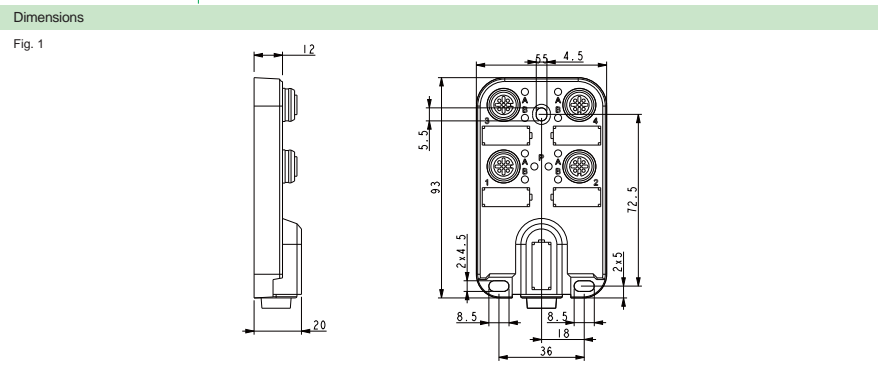
Description:
Plastic housing, 4-way, pre-wired cable, single/double signal.




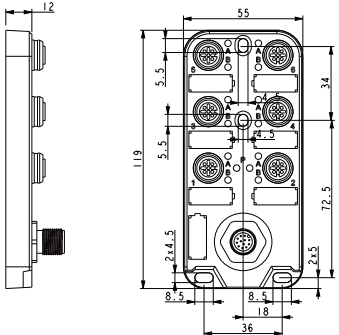
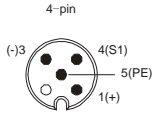
Features:

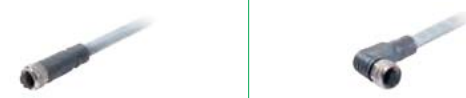
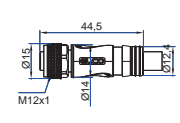
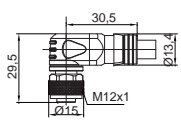
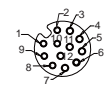
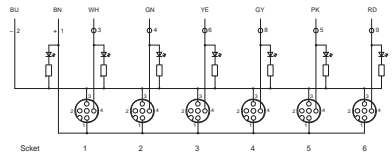
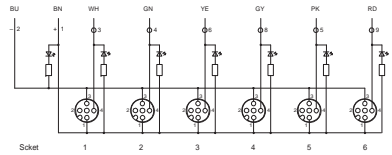
- Optional output (PNP/NPN)
- LED indicator and high protection class IP67
- Standard 3m PUR cable, optional cable length

Type List	ESP4-12-2P-3 / P	ESP4-12-2N-3 / P	ESP4-12-3P-3 / P	ESP4-12-3N-3 / P
Technical Data				
Output Function	1 signal		2 signals	
Output Type	PNP	NPN	PNP	NPN
Connection for Sensors/Actuators	4-pin M12 female		5-pin M12 female	
Locking Sockets	Threaded M12x1			
Dimensions	Fig.1			
Pin Assignment	Fig.2		Fig.3	
Wiring Diagram	Fig.4	Fig.5	Fig.6	Fig.7
Supply Voltage	10...30VDC (24VDC)			
Supply Voltage Indicator	LED green			
I/O Channels	4			
Signals per Port	1		2	
Status Indicators	LED yellow			
Operating Current	Max. 2A			
Current Parameter	Max. 8A			
	Please do not operate cables above max. load capacity.			
Housing Material	Plastic			
	PC + ABS			
Protection Class	IP67			
Temperature Range	-40...+80° C			
Resistance	Good resistance against chemicals and oils. The resistance to aggressive media should be individually verified for your application.			
Cable Material	Standard PUR / PP Bending≥5 million			
Length	3m			



Plastic distribution box ESP6 series (M12 socket, with M12 plug connector)

Description:		
Plastic housing, distributed design, 6-way, single signal.		
Features:		
<ul style="list-style-type: none"> Optional output (PNP/NPN) LED indicator and high protection class IP67 Standard 3m PUR cable for M12 connector, optional cable material and length 		
Type List	ESP6-12-2P-Q12	ESP6-12-2N-Q12
Technical Data		
Output Function	1 signal	
Output Type	PNP	NPN
Connection for Sensors/Actuators	4-pin M12 female	
Locking Sockets	Threaded M12x1	
Dimensions	Fig. 1	
Pin Assignment	Fig. 2	
Wiring Diagram	Fig. 6	Fig. 7
Supply Voltage	10...30VDC (24VDC)	
Supply Voltage Indicator	LED green	
I/O Channels	6	
Signals per Port	1	
Status Indicators	LED yellow	
Operating Current	Max. 1.5A / per contact	
Current Parameter	Max. 1.5A	
	Please do not operate cables above max. load capacity.	
Housing Material	Plastic	
	PC + ABS	
Protection Class	IP67	
Temperature Range	-40...+80 °C	
Resistance	Good resistance against chemicals and oils. The resistance to aggressive media should be individually verified for your application.	
Connector	M12(12pins)	
Dimensions		Pin Assignment
Fig. 1		Fig. 2
		


Accessories of Distribution Box -Connector																												
																												
Type List																												
Type	CO12.12-3 / P	CBO12.12-3 / P																										
Description	Straight pre-wired connector	Angled pre-wired connector																										
Cable Material	Standard PUR / PP Bending \geq 5 million	Standard PUR / PP Bending \geq 5 million																										
Cable Length	3m	3m																										
Dimensions	Fig. 3	Fig. 4																										
Pin Assignment	Fig. 5	Fig. 5																										
Dimensions	Fig. 3	Fig. 4																										
																												
Pin Assignment	Fig. 5																											
		<table border="1"> <thead> <tr> <th>12-pin M12 Male</th> <th>Suggested Cable Color</th> </tr> </thead> <tbody> <tr><td>1</td><td>BN</td></tr> <tr><td>2</td><td>BU</td></tr> <tr><td>3</td><td>WH</td></tr> <tr><td>4</td><td>GN</td></tr> <tr><td>5</td><td>PK</td></tr> <tr><td>6</td><td>YE</td></tr> <tr><td>7</td><td>BK</td></tr> <tr><td>8</td><td>GY</td></tr> <tr><td>9</td><td>RD</td></tr> <tr><td>10</td><td>VF</td></tr> <tr><td>11</td><td>GY/PK</td></tr> <tr><td>12</td><td>RD/BU</td></tr> </tbody> </table>	12-pin M12 Male	Suggested Cable Color	1	BN	2	BU	3	WH	4	GN	5	PK	6	YE	7	BK	8	GY	9	RD	10	VF	11	GY/PK	12	RD/BU
12-pin M12 Male	Suggested Cable Color																											
1	BN																											
2	BU																											
3	WH																											
4	GN																											
5	PK																											
6	YE																											
7	BK																											
8	GY																											
9	RD																											
10	VF																											
11	GY/PK																											
12	RD/BU																											
Wiring Diagram																												
Fig. 6																												
Connector																												
																												
	LED indicator PNP																											
Fig. 7																												
Connector																												
																												
	LED indicator NPN																											

Plastic distribution box ESP6 series (M12 socket, with pre-wired cable)

Description:
Plastic housing, 6-way, pre-wired cable, single/double signal.

Features:

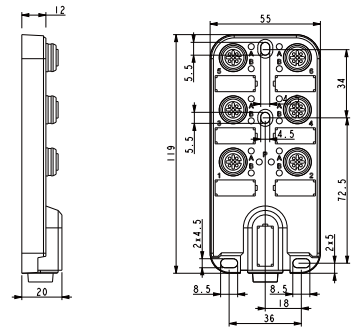
- Optional output (PNP/NPN)
- LED indicator and high protection class IP67
- Standard 3m PUR cable, optional cable length



Type List	ESP6-12-2P-3 / P	ESP6-12-2N-3 / P	ESP6-12-3P-3 / P	ESP6-12-3N-3 / P
Technical Data				
Output Function	1 signal		2 signals	
Output Type	PNP	NPN	PNP	NPN
Connection for Sensors/Actuators	4-pin M12 female		5-pin M12 female	
Locking Sockets	Threaded M12x1			
Dimensions	Fig.1			
Pin Assignment	Fig.2		Fig.3	
Wiring Diagram	Fig.4	Fig.5	Fig.4	Fig.5
Supply Voltage	10...30VDC (24VDC)			
Supply Voltage Indicator	LED green			
I/O Channels	6			
Signals per Port	1		2	
Status Indicators	LED yellow			
Operating Current	Max. 2A / per contact			
Current Parameter	Max. 8A			
	Please do not operate cables above max. load capacity.			
Housing Material	Plastic			
	PC + ABS			
Protection Class	IP67			
Temperature Range	-40...+80°C			
Resistance	Good resistance against chemicals and oils. The resistance to aggressive media should be individually verified for your application.			
Cable Material	Standard PUR / PP Bending≥5 million			
Length	3m			

Dimensions

Fig. 1



Side view dimensions: 12 (width), 20 (depth).

Top view dimensions: 55 (total width), 34 (total height), 11.9 (height to top of terminals), 3.5 (height to top of terminals), 2.4 (height to top of terminals), 8.5 (width to center of terminal), 2.5 (width to center of terminal), 36 (width to center of terminal), 7.5 (height to bottom of terminal), 2.5 (height to bottom of terminal), 18 (width to center of terminal).

Pin Assignment

Fig. 2

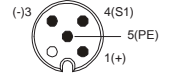
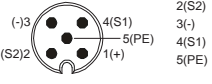
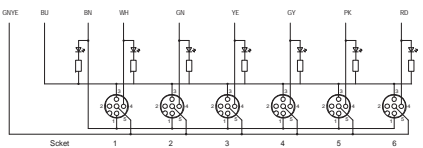


Fig. 3



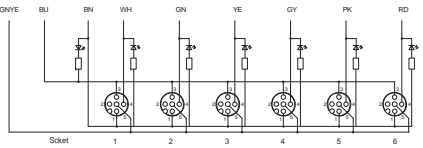
Wiring Diagram

Fig. 4
Cable



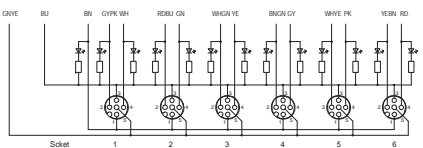
LED indicator PNP

Fig. 5
Cable



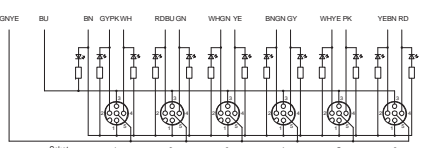
LED indicator NPN

Fig. 6
Cable




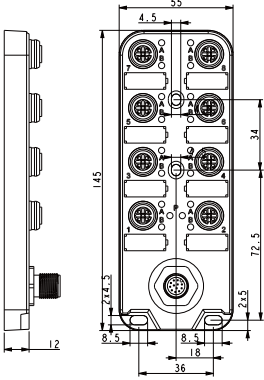
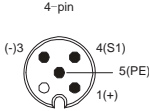
LED indicator PNP


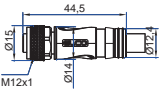
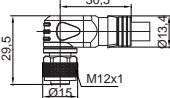

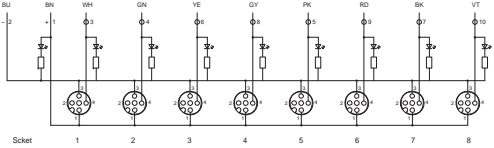
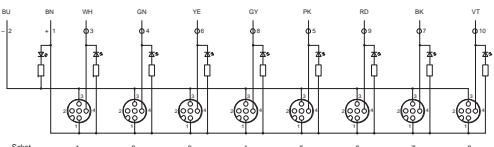
Fig. 7
Cable



LED indicator NPN

Plastic distribution box ESP8 series (M12 socket, with M12 plug connector)

Description:		
Plastic housing, distributed design, 8-way, single signal.		
Features:		
<ul style="list-style-type: none"> Optional output (PNP/NPN) LED indicator and high protection class IP67 Standard 3m PUR cable for M12 connector, optional cable material and length 		
Type List	ESP8-12-2P-Q12	ESP8-12-2N-Q12
Technical Data		
Output Function	1 signal	
Output Type	PNP	NPN
Connection for Sensors/Actuators	4-pin M12 female	
Locking Sockets	Threaded M12x1	
Dimensions	Fig. 1	
Pin Assignment	Fig. 2	
Wiring Diagram	Fig. 6	Fig. 7
Supply Voltage	10...30VDC (24VDC)	
Supply Voltage Indicator	LED green	
I/O Channels	8	
Signals per Port	1	
Status Indicators	LED yellow	
Operating Current	Max. 1.5A / per contact	
Current Parameter	Max. 1.5A	
	Please do not operate cables above max. load capacity.	
Housing Material	Plastic	
	PC + ABS	
Protection Class	IP67	
Temperature Range	-40...+80°C	
Resistance	Good resistance against chemicals and oils. The resistance to aggressive media should be individually verified for your application.	
Connector	M12(12pins)	
Dimensions		
Fig. 1		Pin Assignment
		Fig. 2
		


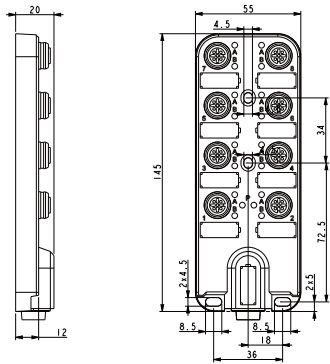
Accessories of Distribution Box -Connector																												
																												
Type List																												
Type	CO12.12-3 / P	CBO12.12-3 / P																										
Description	Straight pre-wired connector	Angled pre-wired connector																										
Cable Material	Standard PUR / PP Bending≥5 million	Standard PUR / PP Bending≥5 million																										
Cable Length	3m	3m																										
Dimensions	Fig. 3	Fig. 4																										
Pin Assignment	Fig. 5	Fig. 5																										
Dimensions																												
Fig. 3		Fig. 4																										
																												
Pin Assignment																												
Fig. 5		<table border="1"> <thead> <tr> <th>12-pin M12 Male</th> <th>Suggested Cable Color</th> </tr> </thead> <tbody> <tr><td>1</td><td>BN</td></tr> <tr><td>2</td><td>BU</td></tr> <tr><td>3</td><td>WH</td></tr> <tr><td>4</td><td>GN</td></tr> <tr><td>5</td><td>PK</td></tr> <tr><td>6</td><td>YE</td></tr> <tr><td>7</td><td>BK</td></tr> <tr><td>8</td><td>GY</td></tr> <tr><td>9</td><td>RD</td></tr> <tr><td>10</td><td>VT</td></tr> <tr><td>11</td><td>GY/PK</td></tr> <tr><td>12</td><td>RD/BU</td></tr> </tbody> </table>	12-pin M12 Male	Suggested Cable Color	1	BN	2	BU	3	WH	4	GN	5	PK	6	YE	7	BK	8	GY	9	RD	10	VT	11	GY/PK	12	RD/BU
12-pin M12 Male	Suggested Cable Color																											
1	BN																											
2	BU																											
3	WH																											
4	GN																											
5	PK																											
6	YE																											
7	BK																											
8	GY																											
9	RD																											
10	VT																											
11	GY/PK																											
12	RD/BU																											
Wiring Diagram																												
Fig. 6																												
Connector	LED indicator PNP																											
Fig. 7																												
Connector	LED indicator NPN																											

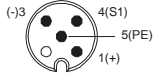
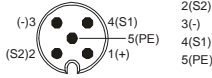
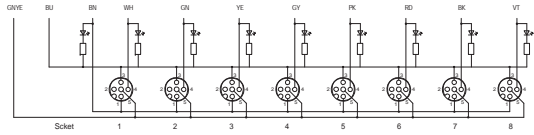
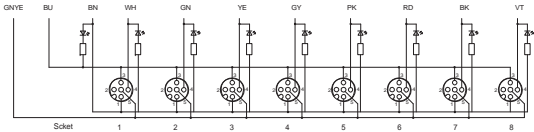
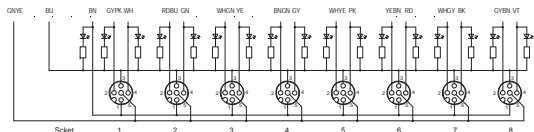
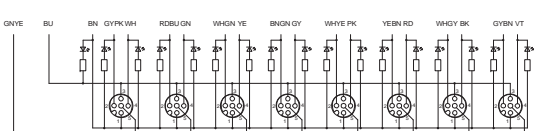
Plastic distribution box ESP8 series (M12 socket, with M23 plug connector)

Description:				
Plastic housing, distributed design, 8-way, single/double signal.				
Features:				
<ul style="list-style-type: none"> Optional output (PNP/NPN) LED indicator and high protection class IP67 Standard 3m PUR cable for M23 connector, optional cable material and length 				
Type List	ESP8-12-2P-Q23	ESP8-12-2N-Q23	ESP8-12-3P-Q23	ESP8-12-3N-Q23
Technical Data				
Output Function	1 signal		2 signals	
Output Type	PNP	NPN	PNP	NPN
Connection for Sensors/Actuators	4-pin M12 female		5-pin M12 female	
Locking Sockets	Threaded M12x1			
Dimensions	Fig. 1			
Pin Assignment	Fig. 2		Fig. 3	
Wiring Diagram	Fig. 8	Fig. 9	Fig. 10	Fig. 11
Supply Voltage	10...30VDC (24VDC)			
Supply Voltage Indicator	LED green			
I/O Channels	8			
Signals per Port	1		2	
Status Indicators	LED yellow			
Operating Current	Max. 2A / per contact			
Current Parameter	Max. 8A			
	Please do not operate cables above max. load capacity.			
Housing Material	Plastic PC + ABS			
Protection Class	IP67			
Temperature Range	-40...+80°C			
Resistance	Good resistance against chemicals and oils. The resistance to aggressive media should be individually verified for your application.			
Connector	M23(19pins)			
Dimensions				
Fig. 1				Pin Assignment Fig. 2 4-pin
				Fig. 3 5-pin

Accessories of Distribution Box -Connector																																																							
Type List																																																							
Type	LSO23.19-0	LSBO23.19-0	CO23.19-3/P																																																				
Description	Straight field-attachment connector	Angled field-attachment connector	Straight pre-wired connector																																																				
Cable Material	--	--	Standard PUR/ PP Bending=5 million																																																				
Cable Length	--	--	3m																																																				
Dimensions	Fig. 4	Fig. 5	Fig. 6																																																				
Pin Assignment	Fig. 7	Fig. 7	Fig. 7																																																				
Dimensions	Fig. 4 	Fig. 5 	Fig. 6 																																																				
Pin Assignment	Fig. 7 	<table border="1"> <thead> <tr> <th>19-pin M19 Male</th> <th>Suggested Cable Color</th> <th>19-pin M19 Male</th> <th>Suggested Cable Color</th> </tr> </thead> <tbody> <tr><td>1</td><td>VT</td><td>13</td><td>YE/BN</td></tr> <tr><td>2</td><td>RD</td><td>14</td><td>BN/GN</td></tr> <tr><td>3</td><td>GY</td><td>15</td><td>WH</td></tr> <tr><td>4</td><td>RD/BU</td><td>16</td><td>YE</td></tr> <tr><td>5</td><td>GN</td><td>17</td><td>PK</td></tr> <tr><td>6</td><td>BU</td><td>18</td><td>GY/BN</td></tr> <tr><td>7</td><td>GY/PK</td><td>19</td><td>BN</td></tr> <tr><td>8</td><td>WH/GN</td><td></td><td></td></tr> <tr><td>9</td><td>WH/YE</td><td></td><td></td></tr> <tr><td>10</td><td>WH/GY</td><td></td><td></td></tr> <tr><td>11</td><td>BK</td><td></td><td></td></tr> <tr><td>12</td><td>GN/YE</td><td></td><td></td></tr> </tbody> </table>		19-pin M19 Male	Suggested Cable Color	19-pin M19 Male	Suggested Cable Color	1	VT	13	YE/BN	2	RD	14	BN/GN	3	GY	15	WH	4	RD/BU	16	YE	5	GN	17	PK	6	BU	18	GY/BN	7	GY/PK	19	BN	8	WH/GN			9	WH/YE			10	WH/GY			11	BK			12	GN/YE		
19-pin M19 Male	Suggested Cable Color	19-pin M19 Male	Suggested Cable Color																																																				
1	VT	13	YE/BN																																																				
2	RD	14	BN/GN																																																				
3	GY	15	WH																																																				
4	RD/BU	16	YE																																																				
5	GN	17	PK																																																				
6	BU	18	GY/BN																																																				
7	GY/PK	19	BN																																																				
8	WH/GN																																																						
9	WH/YE																																																						
10	WH/GY																																																						
11	BK																																																						
12	GN/YE																																																						
Wiring Diagram																																																							
Fig. 8 Connector	<p>LED indicator PNP</p>																																																						
Fig. 9 Connector	<p>LED indicator NPN</p>																																																						
Fig. 10 Connector	<p>LED indicator PNP</p>																																																						
Fig. 11 Connector	<p>LED indicator NPN</p>																																																						

Plastic distribution box ESP8 series (M12 socket, with pre-wired cable)

Description:				
Plastic housing, 8-way, pre-wired cable, single/double signal.				
Features:				
<ul style="list-style-type: none"> Optional output (PNP/NPN) LED indicator and high protection class IP67 Standard 3m PUR cable, optional cable length 				
				
Type List	ESP8-12-2P-3 / P	ESP8-12-2N-3 / P	ESP8-12-3P-3 / P	ESP8-12-3N-3 / P
Technical Data				
Output Function	1 signal		2 signals	
Output Type	PNP	NPN	PNP	NPN
Connection for Sensors/Actuators	4-pin M12 female		5-pin M12 female	
Locking Sockets	Threaded M12x1			
Dimensions	Fig.1			
Pin Assignment	Fig.2		Fig.3	
Wiring Diagram	Fig.4	Fig.5	Fig.4	Fig.5
Supply Voltage	10...30VDC (24VDC)			
Supply Voltage Indicator	LED green			
I/O Channels	8			
Signals per Port	1		2	
Status Indicators	LED yellow			
Operating Current	Max. 2A			
Current Parameter	Max. 8A			
	Please do not operate cables above max. load capacity.			
Housing Material	Plastic			
	PC + ABS			
Protection Class	IP67			
Temperature Range	-40...+80°C			
Resistance	Good resistance against chemicals and oils. The resistance to aggressive media should be individually verified for your application.			
Cable Material	Standard PUR / PP Bending≥5 million			
Length	3m			
Dimensions				
Fig. 1				
				

Pin Assignment	
Fig. 2	Fig. 3
<p>4-pin</p> 	<p>5-pin</p> 
Wiring Diagram	
Fig. 4	
Cable	
 <p>LED indicator PNP</p>	
Fig. 5	
Cable	
 <p>LED indicator NPN</p>	
Fig. 4	
Cable	
 <p>LED indicator PNP</p>	
Fig. 5	
Cable	
 <p>LED indicator NPN</p>	